

## auto electrical parts

### Technical Information Sheet

#### Part No. 0-172-41

Red and white LED outline marker lamp, 12/24 volt with arbitrary polarity, Left Side.  
E Marked.

#### Additional Information:

Bolt Hole Measurements: 68mm Across



#### Technical Drawing (not to scale)

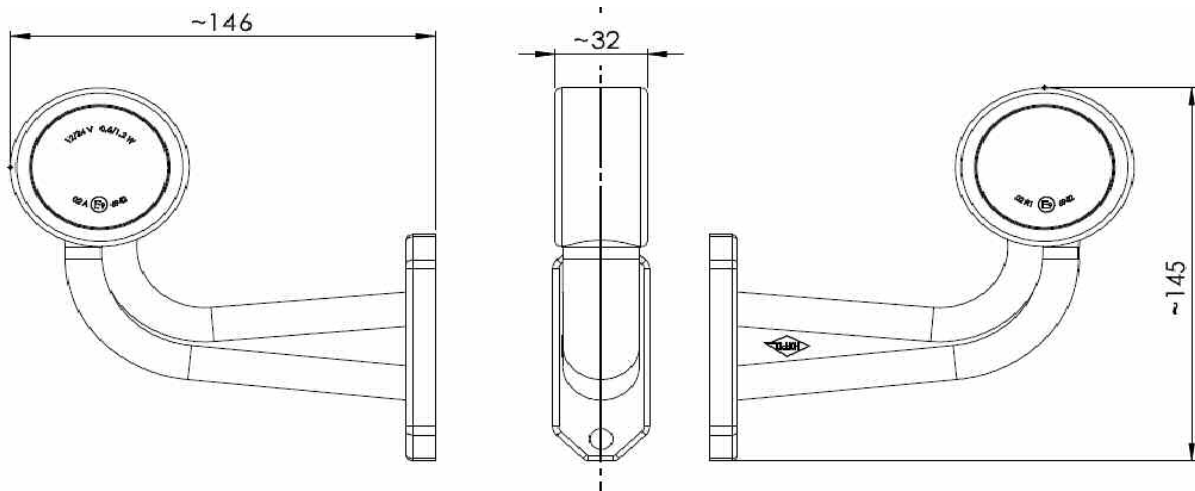

#### Specification

Type	Red and white LED outline marker
Voltage	12/24V
Wattage	0.6W @ 12V, 1.2W @ 24V
Flying leads	50cm twin core
Material	Arm - PVC, Lens - PMMA, Reflector - PC (Aluminium Coated)
Dimensions	As above
IP Rating	IP68
Operating Temperature	-20 to +40 Degrees
Certifications	E Marked

The information contained in this document is correct to the best of our knowledge at the time of printing. However, specifications may change at any time without notice.